

**5** YEAR  
WARRANTY



2024



CUPRA  
**LEON**

MODEL, SPECIFICATION AND PRICES

EXPLORE

# CONTENTS

03 ← THE CUPRA  
LEON

04 ← SELECT  
YOUR TRIM

12 ← E-HYBRID  
BENEFITS

13 ← SELECT YOUR  
ENGINE

17 ← SELECT  
YOUR PAINT  
COLOUR

18 ← EQUIPMENT

31 ← OPTIONS

35 ← TECHNICAL DATA

52 ← VEHICLE EXCISE  
DUTY

53 ← BENEFIT IN  
KIND

54 ← WARRANTIES

55 ← CUPRA CARE  
PLAN

[FIND A RETAILER](#)[TEST DRIVE](#)[CONFIGURE](#)[← CONTENTS →](#)

# THE CUPRA LEON

AN UNBREAKABLE THREAD TIES YOU  
TO YOUR DESTINY.

THIS THREAD TURNS YOUR IDEAS INTO  
A PULSE OF INTENSE EMOTIONS,  
DRIVING YOU TOWARD THE FINISH  
LINE—A JOURNEY BOUND BY PASSION.  
IT IS HERE THAT THE SOUL IS IGNITED AT  
EVERY TURN. THIS ISN'T JUST A DESIRE;  
IT'S THE MAGNETIC FIELD OF YOUR  
WILDEST VISION. AN ATTRACTION SO  
STRONG THAT YOU CAN'T HELP BUT  
EMBRACE IT. THIS IS THE POWER OF  
ATTRACTION, THE DRIVING FORCE  
BEHIND ANY SUCCESSFUL JOURNEY.



[FIND A RETAILER](#)

[TEST DRIVE](#)

[CONFIGURE](#)

[← CONTENTS →](#)

# SELECT YOUR TRIM

- [V1](#)
- [V2](#)
- [V3](#)
- [VZ1](#)
- [VZ2](#)
- [VZ3](#)
- [VZ FIRST EDITION](#)





# LEON V1

PRICE FROM £31,090

## KEY SPECIFICATION FOR THE V1 TRIM

### WHEELS AND TYRES

- 18" 'WINDSTORM' alloy wheels Machined in Sport Black Matt/Silver

### INTERIOR EQUIPMENT

- Interior ambient lighting
- Auto-dimming rear view mirror

### EXTERIOR EQUIPMENT

- Tinted rear windows
- LED Headlights and Taillights, with dynamic indicator and dynamic range control
- Rain sensing wipers
- Rear diffuser with black (copper for e-Hybrid) simulated exhaust pipes

### INFOTAINMENT

- Digital cockpit and configurable dashboard
- 12.9" Navigation system with voice control
- Wireless Apple Carplay
- Wireless phone charger
- CUPRA Connect: Safety, Service, Remote & Online

### SEATS AND TRIM

- Copper and aluminium interior detailing
- Front centre armrest
- Black adjustable sports seats with copper stitching
- Leather multi-function steering wheel (heated with gear shift paddles on DSG)

### FUNCTIONAL AND MECHANICAL

- Front and rear parking sensors
- Electronic parking brake
- Driving profile selection
- Electronic locking differential with dynamic traction support

### SAFETY AND SECURITY

- Predictive Adaptive Cruise control with speed limiter
- Keyless entry
- Forward collision warning with automatic braking
- Driver alert system
- Lane Keeping Assist
- Dynamic road sign display
- High Beam Assist

### WARRANTY

5 Year / 90,000mile Warranty



THE 12.9" INFOTAINMENT TOUCHSCREEN, FEATURES AN UPGRADED OPERATING SYSTEM AND ILLUMINATED SLIDERS FOR ENHANCED AMBIENCE



[VIEW FULL SPEC](#)

The CUPRA Connect services can be operated only by using available public communication technologies. Please note that due to development of these technologies, especially mobile networks, CUPRA cannot guarantee consistent availability in all countries for the duration of CUPRA Connect services. Possible changes in technology may cause permanent unavailability of them.



FIND A RETAILER

TEST DRIVE

CONFIGURE

← CONTENTS →

# LEON V2

PRICE FROM £33,405

IN ADDITION TO THE V1 TRIM

[VIEW FULL SPEC](#)

↓ REAR VIEW CAMERA



Image shown with optional Sennheiser sound system

## UPHOLSTERY

- Black Dinamica with copper stitching and embroidered CUPRA logo in headrest

## FUNCTIONAL AND MECHANICAL

- Rear view camera
- Door mirrors with memory function
- Keyless entry and start (KESY)
- Dynamic chassis control
- Speed sensitive power steering
- Sports suspension with front shock absorption

↓ 19" 'POLAR' ALLOY WHEELS

↑ DYNAMIC DESIGN BUCKET SEATS

## WHEELS AND TYRES

- 19" 'POLAR' alloy wheels in Machined Sport Black and Silver

## EXTERIOR EQUIPMENT

- Electric tailgate with virtual pedal (Estate only)

## INTERIOR EQUIPMENT

- Electrically adjustable seat and lumbar support with memory function for driver seat
- Heated front seats
- Smart wraparound interior lighting





FIND A RETAILER

TEST DRIVE

CONFIGURE

← CONTENTS →



Image shown with optional Sennheiser sound system.

# LEON V3

PRICE FROM £35,055

## IN ADDITION TO THE V2 TRIM

### WHEELS AND TYRES

- 19" 'MISTRAL' alloy wheels in Machined Black and Copper

### INTERIOR EQUIPMENT

- Electrically adjustable seats and lumbar supports with memory function for front seats

### UPHOLSTERY

- Moon Slate Metallic Leather seats and sides in PVC with embroidered CUPRA logo in headrest

### FUNCTIONAL AND MECHANICAL

- Intelligent Park Assist (DSG-auto only)

### SAFETY AND SECURITY

- Advanced lane assist with semi-automatic vehicle control in a medical emergency and traffic jam assist
- Side assist (blind spot monitor) and exit assist
- Pre-crash front and rear seat belt tensioner, window closure and hazard lights

[VIEW FULL SPEC](#)

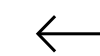

PROGRESSIVE DESIGN BUCKET SEATS



19" 'MISTRAL' ALLOY WHEELS





FIND A RETAILER

TEST DRIVE

CONFIGURE

← CONTENTS →

# LEON VZ1

PRICE FROM £41,465

## IN ADDITION TO THE V1 TRIM

### WHEELS AND TYRES

- 19" 'POLAR' alloy wheels in Machined Sport Black and Silver

### INTERIOR EQUIPMENT

- Electrically adjustable seat and lumbar support with memory function for driver seat
- Heated front seats
- Smart wraparound interior lighting

### EXTERIOR EQUIPMENT

- The CUPRA Matrix LED lights not only improve safety and visibility, but also welcome you with a symbolic illumination each time you unlock your car

### UPHOLSTERY

- Black Dinamica with copper stitching and embroidered CUPRA logo in headrest

### FUNCTIONAL AND MECHANICAL

- Rear view camera
- Electrically adjustable, folding and heated door mirrors with memory function
- Keyless entry and start (KESSY)
- Dynamic chassis control
- Speed sensitive power steering
- Sports suspension with front shock absorption



Image shown with optional Sennheiser sound system



↑ DYNAMIC DESIGN BUCKET SEATS

→ CUPRA MATRIX LED VISION



VIEW FULL SPEC

The CUPRA Connect services can be operated only by using available public communication technologies. Please note that due to development of these technologies, especially mobile networks, CUPRA cannot guarantee consistent availability in all countries for the duration of CUPRA Connect services. Possible changes in technology may cause permanent unavailability of them.





FIND A RETAILER

TEST DRIVE

CONFIGURE

← CONTENTS →

# LEON VZ2

PRICE FROM £43,920

IN ADDITION TO THE VZ1 TRIM

### WHEELS AND TYRES

- 19" 'MISTRAL' alloy wheels in Machined Black and Silver

### FUNCTIONAL AND MECHANICAL

- Intelligent Park Assist

### INTERIOR EQUIPMENT

- Electrically adjustable seats and lumbar supports with memory function for front seats

### UPHOLSTERY

- Moon Slate Metallic Leather seats and sides in PVC with embroidered CUPRA logo in headrest

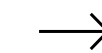

19" 'MISTRAL' ALLOY WHEELS

VIEW FULL SPEC





# LEON VZ3

PRICE FROM £47,250

IN ADDITION TO THE VZ2 TRIM

## WHEELS AND TYRES

- 19" 'HAILSTORM' alloy wheels in Forged Machined Black and Copper

## EXTERIOR EQUIPMENT

- Black Roof Spoiler
- CUPRA Side Skirts – Painted in dark Aluminium

## UPHOLSTERY

- CUP Bucket seats (carbon fibre backs) in textile Turbine and sides in PVC Enceladus Grey with embroidered CUPRA logo in headrest

## INFOTAINMENT

- IMMERSIVE BY Sennheiser TM-10 speakers, 1 central speaker, 1 subwoofer

## FUNCTIONAL AND MECHANICAL

- Performance Brakes and calipers – (Brembo for e-Hybrid) (Akenobo for non- e-Hybrid)

## SAFETY AND SECURITY

- Airbag for driver and front passenger with knee airbag and front passenger airbag deactivation with front side curtain airbags

[VIEW FULL SPEC](#)





FIND A RETAILER

TEST DRIVE

CONFIGURE

← CONTENTS →

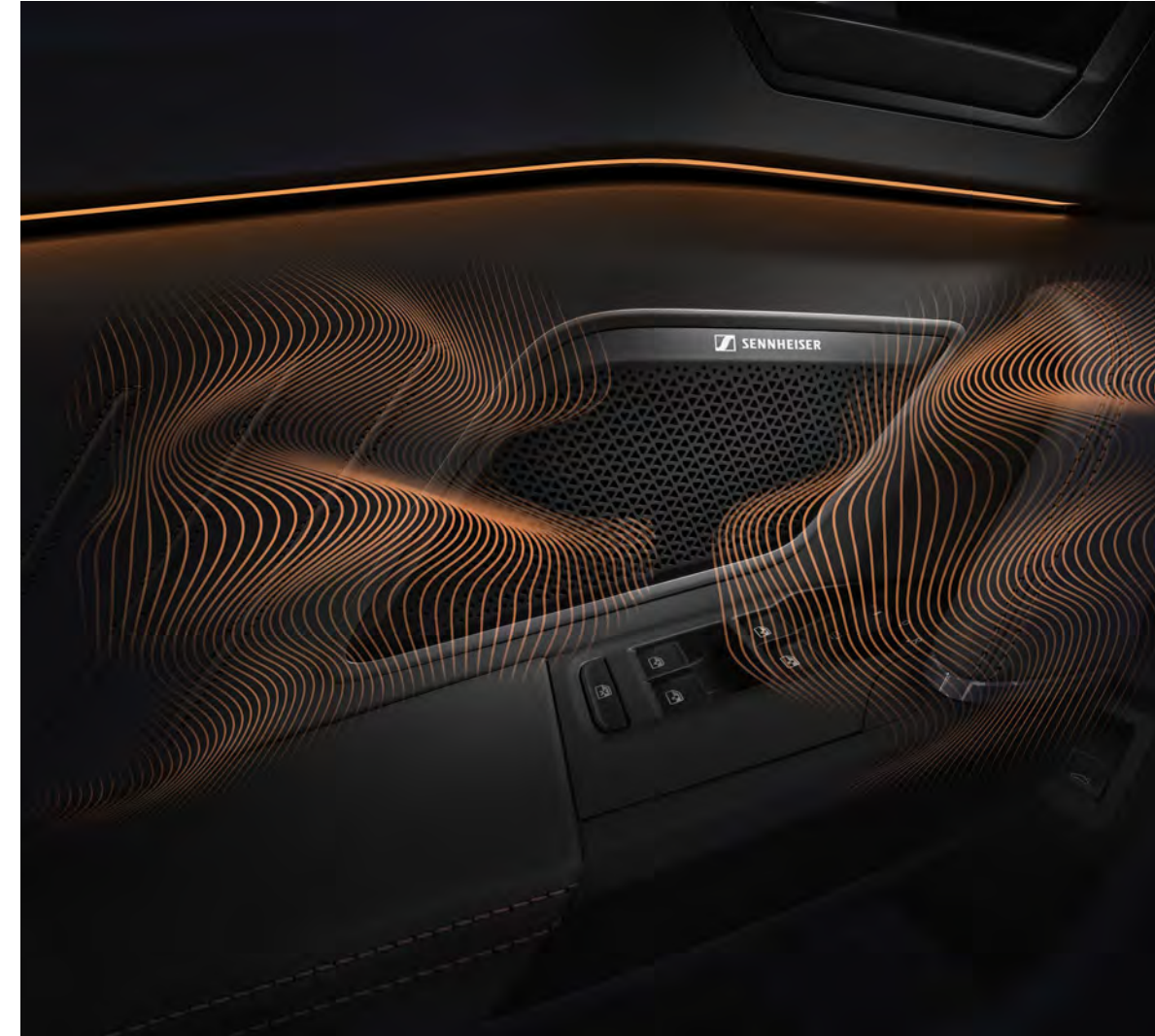

# LEON VZ FIRST EDITION

AVAILABLE FROM £45,850

IN ADDITION TO THE VZ1 TRIM

### WHEELS AND TYRES

- 19" 'POLAR' alloy wheels in Machined Black and Copper

### EXTERIOR EQUIPMENT

- Panoramic sunroof
- CUPRA Side Skirts - Painted in dark Aluminium

### INFOTAINMENT

- IMMERSIVE BY Sennheiser TM - 10 speakers, 1 central speaker, 1 subwoofer

### FUNCTIONAL AND MECHANICAL

- Intelligent park assist

### SAFETY AND SECURITY

- Advanced lane assist with semi-automatic vehicle control in a medical emergency and traffic jam assist
- Side assist (blind spot monitor) and exit assist
- Pre-crash front and rear seat belt tensioner, window closure and hazard lights

[VIEW FULL SPEC](#)

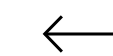

DYNAMIC DESIGN  
BUCKET SEATS



# E-HYBRID BENEFITS

## GO FURTHER FOR LESS

e-HYBRID can achieve up to 706\* miles per gallon making them more fuel efficient than pure combustion engines.

## BEST OF BOTH WORLDS

Choose from either our 204PS or 272PS e-HYBRID powertrains.

Drive in three modes: All electric; pure TSI engine; or a combination of the two.

## FREEDOM TO MOVE

An all electric range of up to 81 miles allows for emission-free urban driving.

## LOWER TAXATION

CUPRA LEON e-HYBRID have a 5% Benefit in Kind (BIK) taxation and lower Road Fund Licence (RFL) than their equivalent combustion engine counterparts.

## EFFICIENT AND CONNECTED CHARGING SOLUTIONS

Charge with either a DC fast-charger or at home with an AC wallbox. Being able to charge from 10-80% on a 50Kw fast charger in 26minutes whilst also monitoring activity via your smartphone with CUPRA CONNECT.

CUPRA Leon e-HYBRID comes with a MODE 2 (3-pin) and a MODE 3 (charging station) cable as standard.

\*WLTP combined MPG.

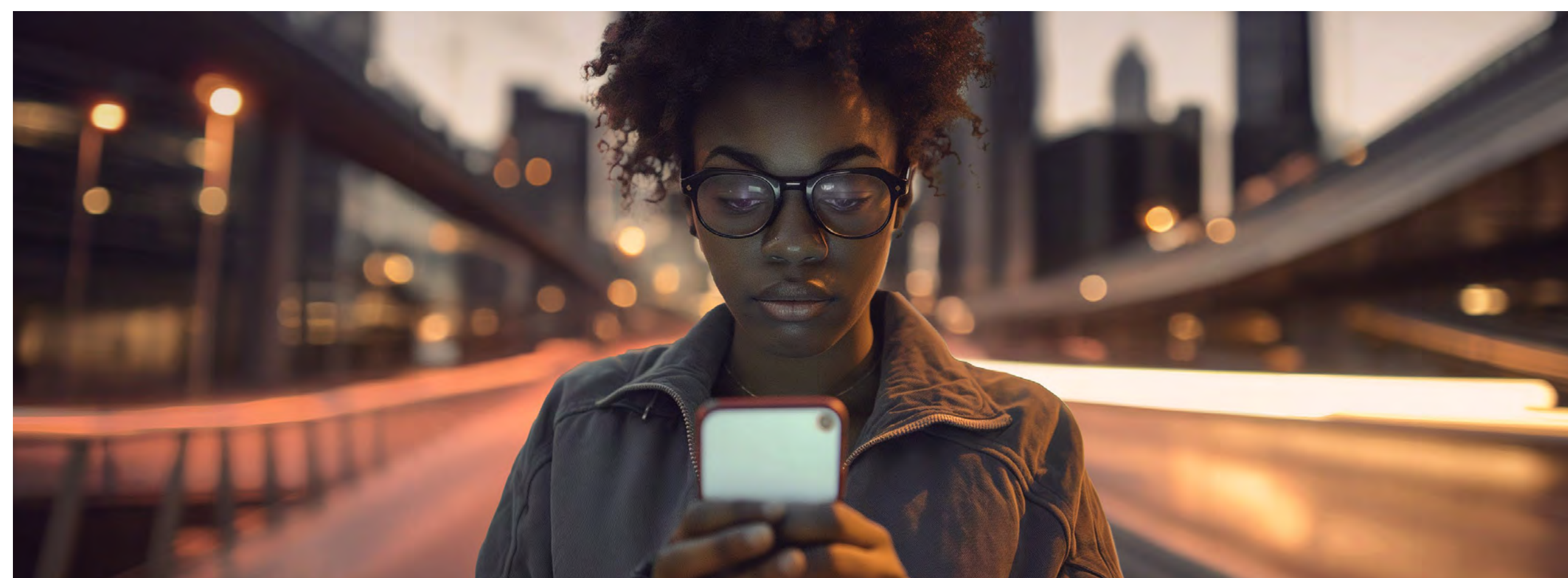

[FIND A RETAILER](#)[TEST DRIVE](#)[CONFIGURE](#)[← CONTENTS →](#)

# SELECT YOUR ENGINE

CUPRA LEON 5DR	FUEL	CAPACITY (L)	WLTP CO <sub>2</sub> G/KM	WLTP COMBINED MPG	BIK 2024/25*	BASE PRICE (EXCL. VAT)	VAT @ 20.0%	RETAIL PRICE (P11D VALUE)	1ST YEAR RFL RATE 2024/25	STANDARD RFL RATE 2024/25	1ST REG FEE 2024/25	RECOMMENDED ON THE ROAD PRICE	
V1	CUPRA Leon Hatch V1 TSI 150	P	1.5	132	44.8-48.7	31%	£25,637.50	£5,127.50	£30,765.00	£270.00	£190.00	£55.00	£31,090.00
	CUPRA Leon Hatch V1 eTSI DSG-auto 150	AFV	1.5	124	47.9-51.4	29%	£27,250.00	£5,450.00	£32,700.00	£210.00	£180.00	£55.00	£32,965.00
	CUPRA Leon Hatch V1 e-HYBRID DSG-auto 204	AFV	1.5	9	706.2-706.2	5%	£32,404.17	£6,480.83	£38,885.00	£0.00	£180.00	£55.00	£38,940.00
V2	CUPRA Leon Hatch V2 TSI 150	P	1.5	137	44.8-47.1	32%	£27,566.67	£5,513.33	£33,080.00	£270.00	£190.00	£55.00	£33,405.00
	CUPRA Leon Hatch V2 eTSI DSG-auto 150	AFV	1.5	129	47.9-49.6	30%	£29,166.67	£5,833.33	£35,000.00	£210.00	£180.00	£55.00	£35,265.00
	CUPRA Leon Hatch V2 e-HYBRID DSG-auto 204	AFV	1.5	9	706.2-706.2	5%	£34,320.83	£6,864.17	£41,185.00	£0.00	£590.00	£55.00	£41,240.00
V3	CUPRA Leon Hatch V3 TSI 150	P	1.5	137	44.8-47.1	32%	£28,941.67	£5,788.33	£34,730.00	£270.00	£190.00	£55.00	£35,055.00
	CUPRA Leon Hatch V3 eTSI DSG-auto 150	AFV	1.5	129	47.9-50.4	30%	£30,779.17	£6,155.83	£36,935.00	£210.00	£180.00	£55.00	£37,200.00
	CUPRA Leon Hatch V3 e-HYBRID DSG-auto 204	AFV	1.5	8	706.2-706.2	5%	£35,933.33	£7,186.67	£43,120.00	£0.00	£590.00	£55.00	£43,175.00

\*BIK value is based on WLTP CO<sub>2</sub> and applicable from 23/07/2024.

All prices shown are MDP (Manufacturer's Direct Price), inclusive of VAT. Sold by CUPRA UK, a trading division of Volkswagen Group United Kingdom Limited. MDP includes: delivery to Agent, number plates, new vehicle registration fee, the first year's Vehicle Excise Duty and VAT (calculated at 20%). CUPRA UK may change the MDP at any time (this includes where there are government changes in regulation and/or legislation). There may be a delay to any MDP prices displaying correctly on our materials. Figures shown are for comparability purposes; only compare fuel consumption and CO<sub>2</sub> figures with other vehicles tested to the same technical procedures. These figures may not reflect real life driving results, which will depend upon a number of factors including the accessories fitted (post-registration), variations in weather, driving styles and vehicle load. Data correct at 23/07/2024. Figures quoted are for a range of configurations and are subject to change due to ongoing approvals/changes.

[FINANCE CALCULATOR](#)

[FIND A RETAILER](#)[TEST DRIVE](#)[CONFIGURE](#)[← CONTENTS →](#)

# SELECT YOUR ENGINE

CUPRA LEON 5DR	FUEL	CAPACITY (L)	WLTP CO <sub>2</sub> G/KM	WLTP COMBINED MPG	BIK 2024/25*	BASE PRICE (EXCL. VAT)	VAT @ 20.0%	RETAIL PRICE (P11D VALUE)	1ST YEAR RFL RATE 2024/25	STANDARD RFL RATE 2024/25	1ST REG FEE 2024/25	RECOMMENDED ON THE ROAD PRICE	
VZ1	CUPRA Leon Hatch VZ1 e-HYBRID DSG-auto 272	AFV	1.5	9	706.2-706.2	5%	£35,016.67	£7,003.33	£42,020.00	£0.00	£590.00	£55.00	£42,075.00
	CUPRA Leon Hatch VZ1 TSI DSG-auto 300	P	2	174	36.2-36.7	37%	£33,595.83	£6,719.17	£40,315.00	£1,095.00	£600.00	£55.00	£41,465.00
VZ2	CUPRA Leon Hatch VZ2 e-HYBRID DSG-auto 272	AFV	1.5	9	706.2-706.2	5%	£37,062.50	£7,412.50	£44,475.00	£0.00	£590.00	£55.00	£44,530.00
	CUPRA Leon Hatch VZ2 TSI DSG-auto 300	P	2	173	36.2-37.2	37%	£35,641.67	£7,128.33	£42,770.00	£1,095.00	£600.00	£55.00	£43,920.00
VZ3	CUPRA Leon Hatch VZ3 e-HYBRID DSG-auto 272	AFV	1.5	10	706.2-706.2	5%	£39,837.50	£7,967.50	£47,805.00	£0.00	£590.00	£55.00	£47,860.00
	CUPRA Leon Hatch VZ3 TSI DSG-auto 300	P	2	175	36.2-36.7	37%	£38,416.67	£7,683.33	£46,100.00	£1,095.00	£600.00	£55.00	£47,250.00
VZ FIRST EDITION	CUPRA Leon Hatch VZ First Edition e-HYBRID DSG-auto 272	AFV	1.5	10	706.2-706.2	5%	£38,162.50	£7,632.50	£45,795.00	£0.00	£590.00	£55.00	£45,850.00

\*BIK value is based on WLTP CO<sub>2</sub> and applicable from 23/07/2024.  
 All prices shown are MDP (Manufacturer's Direct Price), inclusive of VAT. Sold by CUPRA UK, a trading division of Volkswagen Group United Kingdom Limited. MDP includes: delivery to Agent, number plates, new vehicle registration fee, the first year's Vehicle Excise Duty and VAT (calculated at 20%). CUPRA UK may change the MDP at any time (this includes where there are government changes in regulation and/or legislation). There may be a delay to any MDP prices displaying correctly on our materials. Figures shown are for comparability purposes; only compare fuel consumption and CO<sub>2</sub> figures with other vehicles tested to the same technical procedures. These figures may not reflect real life driving results, which will depend upon a number of factors including the accessories fitted (post-registration), variations in weather, driving styles and vehicle load. Data correct at 23/07/2024. Figures quoted are for a range of configurations and are subject to change due to ongoing approvals/changes.

[FINANCE CALCULATOR](#)

[FIND A RETAILER](#)[TEST DRIVE](#)[CONFIGURE](#)[← CONTENTS →](#)

# SELECT YOUR ENGINE

CUPRA LEON ESTATE	FUEL	CAPACITY (L)	WLTP CO <sub>2</sub> G/KM	WLTP COMBINED MPG	BIK 2024/25*	BASE PRICE (EXCL. VAT)	VAT @ 20.0%	RETAIL PRICE (P11D VALUE)	1ST YEAR RFL RATE 2024/25	STANDARD RFL RATE 2024/25	1ST REG FEE 2024/25	RECOMMENDED ON THE ROAD PRICE	
V1	CUPRA Leon Estate V1 TSI 150	P	1.5	134	44.1-47.9	31%	£27,537.50	£5,507.50	£33,045.00	£270.00	£190.00	£55.00	£33,370.00
	CUPRA Leon Estate V1 eTSI DSG-auto 150	AFV	1.5	126	47.1-51.4	30%	£29,150.00	£5,830.00	£34,980.00	£210.00	£180.00	£55.00	£35,245.00
	CUPRA Leon Estate V1 e-HYBRID DSG-auto 204	AFV	1.5	9	706.2-706.2	5%	£34,304.17	£6,860.83	£41,165.00	£0.00	£590.00	£55.00	£41,220.00
V2	CUPRA Leon Estate V2 TSI 150	P	1.5	139	44.1-46.3	32%	£29,658.33	£5,931.67	£35,590.00	£270.00	£190.00	£55.00	£35,915.00
	CUPRA Leon Estate V2 eTSI DSG-auto 150	AFV	1.5	130	47.1-49.6	31%	£31,258.33	£6,251.67	£37,510.00	£210.00	£180.00	£55.00	£37,775.00
	CUPRA Leon Estate V2 e-HYBRID DSG-auto 204	AFV	1.5	9	706.2-706.2	5%	£36,412.50	£7,282.50	£43,695.00	£0.00	£590.00	£55.00	£43,750.00
V3	CUPRA Leon Estate V3 TSI 150	P	1.5	139	44.1-46.3	32%	£31,033.33	£6,206.67	£37,240.00	£270.00	£190.00	£55.00	£37,565.00
	CUPRA Leon Estate V3 eTSI DSG-auto 150	AFV	1.5	130	47.1-49.6	31%	£32,870.83	£6,574.17	£39,445.00	£210.00	£180.00	£55.00	£39,710.00
	CUPRA Leon Estate V3 e-HYBRID DSG-auto 204	AFV	1.5	9	706.2-706.2	5%	£38,025.00	£7,605.00	£45,630.00	£0.00	£590.00	£55.00	£45,685.00

\*BIK value is based on WLTP CO<sub>2</sub> and applicable from 23/07/2024.

All prices shown are MDP (Manufacturer's Direct Price), inclusive of VAT. Sold by CUPRA UK, a trading division of Volkswagen Group United Kingdom Limited. MDP includes: delivery to Agent, number plates, new vehicle registration fee, the first year's Vehicle Excise Duty and VAT (calculated at 20%). CUPRA UK may change the MDP at any time (this includes where there are government changes in regulation and/or legislation). There may be a delay to any MDP prices displaying correctly on our materials. Figures shown are for comparability purposes; only compare fuel consumption and CO<sub>2</sub> figures with other vehicles tested to the same technical procedures. These figures may not reflect real life driving results, which will depend upon a number of factors including the accessories fitted (post-registration), variations in weather, driving styles and vehicle load. Data correct at 23/07/2024. Figures quoted are for a range of configurations and are subject to change due to ongoing approvals/changes.

[FINANCE CALCULATOR](#)

[FIND A RETAILER](#)[TEST DRIVE](#)[CONFIGURE](#)[← CONTENTS →](#)

# SELECT YOUR ENGINE

CUPRA LEON ESTATE	FUEL	CAPACITY (L)	WLTP CO <sub>2</sub> G/KM	WLTP COMBINED MPG	BIK 2024/25*	BASE PRICE (EXCL. VAT)	VAT @ 20.0%	RETAIL PRICE (P11D VALUE)	1ST YEAR RFL RATE 2024/25	STANDARD RFL RATE 2024/25	1ST REG FEE 2024/25	RECOMMENDED ON THE ROAD PRICE	
VZ1	CUPRA Leon Estate VZ1 e-HYBRID DSG-auto 272	AFV	1.5	10	565.0-706.2	5%	£36,954.17	£7,390.83	£44,345.00	£0.00	£590.00	£55.00	£44,400.00
	CUPRA Leon Estate VZ1 TSI DSG-auto 4Drive 333	P	2.0	188	32.5-34.0	37%	£36,700.00	£7,340.00	£44,040.00	£1,095.00	£600.00	£55.00	£45,190.00
VZ2	CUPRA Leon Estate VZ2 e-HYBRID DSG-auto 272	AFV	1.5	10	565.0-706.2	5%	£39,000.00	£7,800.00	£46,800.00	£0.00	£590.00	£55.00	£46,855.00
	CUPRA Leon Estate VZ2 TSI DSG-auto 4Drive 333	P	2.0	188	32.5-34.0	37%	£38,745.83	£7,749.17	£46,495.00	£1,095.00	£600.00	£55.00	£47,645.00
VZ3	CUPRA Leon Estate VZ3 e-HYBRID DSG-auto 272	AFV	1.5	10	565.0-706.2	5%	£41,775.00	£8,355.00	£50,130.00	£0.00	£590.00	£55.00	£50,185.00
	CUPRA Leon Estate VZ3 TSI DSG-auto 4Drive 333	P	2.0	189	32.5-34.0	37%	£41,520.83	£8,304.17	£49,825.00	£1,095.00	£600.00	£55.00	£50,975.00
VZ FIRST EDITION	CUPRA Leon Hatch VZ First Edition e-HYBRID DSG-auto 272	AFV	1.5	11	565.0-565.0	5%	£40,179.17	£8,035.83	£48,215.00	£0.00	£590.00	£55.00	£48,270.00

\*BIK value is based on WLTP CO<sub>2</sub> and applicable from 23/07/2024.  
 All prices shown are MDP (Manufacturer's Direct Price), inclusive of VAT. Sold by CUPRA UK, a trading division of Volkswagen Group United Kingdom Limited. MDP includes: delivery to Agent, number plates, new vehicle registration fee, the first year's Vehicle Excise Duty and VAT (calculated at 20%). CUPRA UK may change the MDP at any time (this includes where there are government changes in regulation and/or legislation). There may be a delay to any MDP prices displaying correctly on our materials. Figures shown are for comparability purposes; only compare fuel consumption and CO<sub>2</sub> figures with other vehicles tested to the same technical procedures. These figures may not reflect real life driving results, which will depend upon a number of factors including the accessories fitted (post-registration), variations in weather, driving styles and vehicle load. Data correct at 23/07/2024. Figures quoted are for a range of configurations and are subject to change due to ongoing approvals/changes.

[FINANCE CALCULATOR](#)





FIND A RETAILER

TEST DRIVE

CONFIGURE

← CONTENTS →

# SELECT YOUR PAINT COLOUR

NON-METALLIC



FIORD BLUE

V1 | V2 | V3 | VZ1 | VZ2 | VZ3

METALLIC



MAGNETIC  
TECH GREY

V1 | V2 | V3 | VZ1 | VZ2 | VZ3



MIDNIGHT  
BLACK

V1 | V2 | V3 | VZ1 | VZ2 | VZ3



GLACIAL  
WHITE

V1 | V2 | V3 | VZ1 | VZ2 | VZ3

PREMIUM METALLIC



GRAPHENE  
GREY

V1 | V2 | V3 | VZ1 | VZ2 | VZ3 | VZ FIRST EDITION



TAIGA  
GREY

V1 | V2 | V3 | VZ1 | VZ2 | VZ3

MATTE

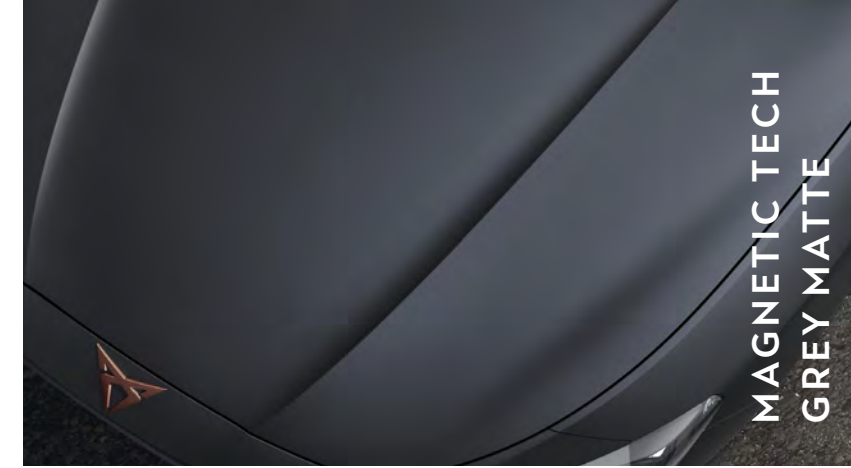

MAGNETIC TECH  
GREY MATTE

V1 | V2 | V3 | VZ1 | VZ2 | VZ3

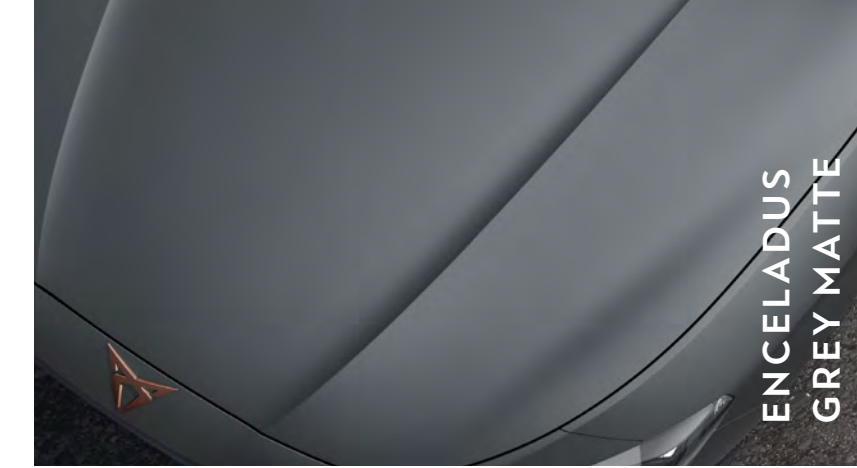

ENCELADUS  
GREY MATTE

VZ1 | VZ2 | VZ3 | VZ FIRST EDITION



CENTURY  
BRONZE MATTE

VZ1 | VZ2 | VZ3



# WHEELS AND TYRES

	V1	V2	V3	VZ1	VZ2	VZ3	VZ FIRST EDITION
18" 'WINDSTORM' alloy wheels Machined in Sport Black Matt/Silver with 225/40 R18 92Y XL tyres	▼	-	-	-	-	-	-
19" 'POLAR' alloy wheels in Machined Sport Black and Silver with 235/35 R19 91Y tyres	-	▼	-	▼	-	-	-
19" 'POLAR' alloy wheels in Machined Black and Copper with 235/35 R19 91Y tyres	-	-	-	-	-	-	▼
19" 'MISTRAL' alloy wheels in Machined Black and Copper with 235/35 R19 91Y tyres	-	-	▼	-	-	-	-
19" 'MISTRAL' alloy wheels in Machined Black and Silver with 235/35 R19 91Y tyres	-	-	▽	-	▼	-	-
19" 'HAILSTORM' alloy wheels in Forged Machined Black and Copper with 235/35 R19 91Y tyres	-	-	-	-	-	▼	-
Breakdown kit	▼	▼	▼	▼	▼	▼	▼
Tool Kit	▼	▼	▼	▼	▼	▼	▼

▼ STANDARD | ▽ OPTIONAL | - NOT AVAILABLE



## EXTERIOR EQUIPMENT

	V1	V2	V3	VZ1	VZ2	VZ3	VZ FIRST EDITION
Dark tinted rear windows	▼	▼	▼	▼	▼	▼	▼
Door mirrors (electrically adjustable, folding and heated)	▼	▼	▼	▼	▼	▼	▼
Welcome light with CUPRA logo projector in door mirrors	▼	▼	▼	▼	▼	▼	▼
LED Headlights with dynamic turn signals, LED tail lights and rear fog lights with rear coast to coast lighting	▼	▼	▼	-	-	-	-
<b>Matrix LED Headlights</b>							
- LED Headlamps with variable light distribution	-	-	-	▼	▼	▼	▼
- Matrix beam	-	-	-	▼	▼	▼	▼
- Dynamic headlight range control	-	-	-	▼	▼	▼	▼
LED Front fog lamps with cornering function	▼	▼	▼	▼	▼	▼	▼
LED rear fog lamps	▼	▼	▼	▼	▼	▼	▼
Rain sensing wipers	▼	▼	▼	▼	▼	▼	▼
Roof rails in glossy black (Estate only)	▼	▼	▼	▼	▼	▼	▼

▼ STANDARD | ▽ OPTIONAL | - NOT AVAILABLE



## EXTERIOR EQUIPMENT

	V1	V2	V3	VZ1	VZ2	VZ3	VZ FIRST EDITION
Separate daytime running light with automatic headlight control and Coming Home feature (automatic)	▼	▼	▼	▼	▼	▼	▼
CUPRA Sports bumpers	▼	▼	▼	▼	▼	▼	▼
CUPRA Black brake calipers	▼	▼	▼	▼	▼	-	▼
Brembo Brakes (Discs brakes + Brembo caliper) (Not available on TSI Petrol)	-	-	-	-	-	▼ e-Hybrid	-
Akebono Brakes (Discs brakes + Akebono caliper) (Not available on e-Hybrid)	-	-	-	-	-	▼ Petrol TSI	-
CUPRA Side Skirts – painted in Dark Aluminium	-	-	-	-	-	▼	▼
Black Roof Spoiler	-	-	-	-	-	▼	-
Panoramic sunroof	-	▽	▽	▽	▽	▽	▼

▼ STANDARD | ▽ OPTIONAL | - NOT AVAILABLE



# INFOTAINMENT

	V1	V2	V3	VZ1	VZ2	VZ3	VZ FIRST EDITION
Digital cockpit	▼	▼	▼	▼	▼	▼	▼
Full Link smartphone integration (Mirror Link, Wireless Apple CarPlay, Wired Google Android Auto)	▼	▼	▼	▼	▼	▼	▼
<b>Media System with Navigation</b>							
- 12,9" Touchscreen Display							
- DAB (Digital Audio Broadcasting) and AM/FM radio							
- Bluetooth® audio streaming and handsfree system	▼	▼	▼	▼	▼	▼	▼
- Steering wheel-mounted audio and phone controls							
- Navigation system							
- Natural voice control							
Seven Speakers	▼	▼	▼	▼	▼	-	-
<b>IMMERSIVE BY Sennheiser™</b>							
10 speakers, 1 central speaker, 1 subwoofer	-	▽	▽	▽	▽	▼	▼
2 front & 2 rear USB type C sockets	▼	▼	▼	▼	▼	▼	▼
Wireless phone charger	▼	▼	▼	▼	▼	▼	▼
12 v socket	▼	▼	▼	▼	▼	▼	▼

The CUPRA Connect services can be operated only by using available public communication technologies. Please note that due to development of these technologies, especially mobile networks, CUPRA cannot guarantee consistent availability in all countries for the duration of CUPRA Connect services. Possible changes in technology may cause permanent unavailability of them.

▼ STANDARD | ▽ OPTIONAL | - NOT AVAILABLE



# INFOTAINMENT

	V1	V2	V3	VZ1	VZ2	VZ3	VZ FIRST EDITION
<b>CUPRA Connect: Safety, Service and Remote</b>							
Safety & Service: 10 year subscription included:							
- Private emergency call							
- Breakdown call							
- Service scheduling							
Remote Access: 10 years subscription included:	▼	▼	▼	▼	▼	▼	▼
- Driving data							
- Remote Climatisation (e-hybrids only)							
- Parking position							
- Remote lock and unlock							
- Anti-theft / area / speed alert							
<b>CUPRA Connect PLUS: Safety, Service, Remote &amp; Online</b>							
As per CUPRA Connect: Safety, Service and Remote & plus:							
- Online infotainment: 3 years subscription included							
- Online map update	▼	▼	▼	▼	▼	▼	▼
- Online traffic information							
- Online route calculation							
- Parking and petrol stations							

The CUPRA Connect services can be operated only by using available public communication technologies. Please note that due to development of these technologies, especially mobile networks, SEAT cannot guarantee consistent availability in all countries for the duration of SEAT Connect services. Possible changes in technology may cause permanent unavailability of them.

▼ STANDARD | ▽ OPTIONAL | - NOT AVAILABLE



# INTERIOR EQUIPMENT

	V1	V2	V3	VZ1	VZ2	VZ3	VZ FIRST EDITION
Ambient lighting (glovebox, footwell, ambient lighting multicoloured)	-	▼	▼	▼	▼	▼	▼
Ambient lighting (glovebox, footwell and single monocolour)	▼	-	-	-	-	-	-
Auto-dimming rear view mirror	▼	▼	▼	▼	▼	▼	▼
Front centre armrest	▼	▼	▼	▼	▼	▼	▼
Front and rear reading lights (four)	▼	▼	▼	▼	▼	▼	▼
Interior Wraparound lighting	-	▼	▼	▼	▼	▼	▼
Sunvisors with illuminated mirror	▼	▼	▼	▼	▼	▼	▼



## SEATS AND TRIM

	V1	V2	V3	VZ1	VZ2	VZ3	VZ FIRST EDITION
Black headlining	▼	▼	▼	▼	▼	▼	▼
Chrome and copper interior detailing	▼	▼	▼	▼	▼	-	▼
Dark Chrome interior detailing	-	-	-	-	-	▼	-
Illuminated front door sill	▼	▼	▼	▼	▼	▼	▼
Black Sports seats, part PVC part cloth with copper stitching	▼	-	-	-	-	-	-
Manually adjustable height and lumbar support for front seats	▼	-	-	-	-	-	-
Heated front seats	-	▼	▼	▼	▼	▼	▼
Black Dinamica Bucket seats part PVC with copper stitching and embroidered CUPRA logo in headrest including:							
- Electrically adjustable seat and lumbar support with memory function for driver seat	-	▼	-	▼	-	-	▼
- Leather dashboard with Dinamica door insert and side trim panel							

▼ STANDARD | ▽ OPTIONAL | - NOT AVAILABLE





## SEATS AND TRIM

	V1	V2	V3	VZ1	VZ2	VZ3	VZ FIRST EDITION
Moon Slate Metallic Leather seats and sides in PVC with embroidered CUPRA logo in headrest including: - Electrically adjustable seats and lumbar supports with memory function for front seats - Leather dashboard, door insert and side trim panel	-	-	▼	-	▼	-	-
CUP Bucket seats in textile Turbine and sides in PVC Enceladus Grey with embroidered CUPRA logo in headrest including: - Electrically adjustable seats and lumbar supports with memory function for front seats - Leather dashboard, door insert and side trim panel	-	-	-	-	-	▼	-
Rear bench seats with 60 / 40 split and armrest	▼	▼	▼	▼	▼	▼	▼
Storage pockets on rear of front seats	▼	▼	▼	▼	▼	-	▼
CUPRA Leather flat bottomed, perforated steering wheel	▼ (Manual only)	▼ (Manual only)	▼ (Manual only)	-	-	-	-
CUPRA Supersports, heated steering wheel with satellite buttons	▼ (DSG only)	▼ (DSG only)	▼ (DSG only)	▼	▼	▼	▼
CUPRA Sports pedals	▼ (DSG only)	▼ (DSG only)	▼ (DSG only)	▼	▼	▼	▼

▼ STANDARD | ▽ OPTIONAL | - NOT AVAILABLE



# FUNCTIONAL AND MECHANICAL

	V1	V2	V3	VZ1	VZ2	VZ3	VZ FIRST EDITION
12v power supply in centre console	▼	▼	▼	▼	▼	▼	▼
Charging cable mode 2, 10amp	▼ e-hybrid only	▼ e-hybrid only	▼ e-hybrid only	▼ e-hybrid only	▼ e-hybrid only	▼ e-hybrid only	▼
Charging cable mode 3, 32amp	▼ e-hybrid only	▼ e-hybrid only	▼ e-hybrid only	▼ e-hybrid only	▼ e-hybrid only	▼ e-hybrid only	▼
<b>CUPRA drive profile selection</b> - Four different modes (Comfort-Performance-Cupra-Individual) <sup>1</sup> - Throttle response - Gear shifts mode	▼	▼	▼	▼	▼	▼	▼
<b>CUPRA Dynamic and Comfort Pack</b> - Speed sensitive power steering - Dynamic chassis control	-	▼	▼	▼	▼	▼	▼
Electric front and rear windows	▼	▼	▼	▼	▼	▼	▼

1. Cupra mode in driver profile selection not available on V1.



## FUNCTIONAL AND MECHANICAL

	V1	V2	V3	VZ1	VZ2	VZ3	VZ FIRST EDITION
Electronic parking brake	▼	▼	▼	▼	▼	▼	▼
Front and rear parking sensors	▼	▼	▼	▼	▼	▼	▼
Intelligent Park Assist (Not available on 1.5 TSI 150PS Manual)	-	-	▼ (DSG-auto only)	-	▼	▼	▼
Rear disc brakes	▼	▼	▼	▼	▼	▼	▼
Rear view camera	-	▼	▼	▼	▼	▼	▼
Start-stop and regenerative braking	▼	▼	▼	▼	▼	▼	▼
Three zone climate control	▼	▼	▼	▼	▼	▼	▼
Virtual pedal with electric tailgate (Estate only)	-	▼	▼	▼	▼	▼	▼



# SAFETY AND SECURITY

	V1	V2	V3	VZ1	VZ2	VZ3	VZ FIRST EDITION
Anti-theft alarm system, interior monitoring, backup horn, and towing protection	▼	▼	▼	▼	▼	▼	▼
Brake control system (ESC and brake booster)	▼	▼	▼	▼	▼	▼	▼
Adaptive cruise control with follow-to-stop and speed limiter	▼	▼	▼	▼	▼	▼	▼
Airbag for driver and front passenger with front passenger airbag deactivation with front side curtain airbags	▼	▼	▼	▼	▼	-	▼
Airbag for driver and front passenger with knee airbag and front passenger airbag deactivation with front side curtain airbags	-	-	-	-	-	▼	-
High Beam Assist	▼	▼	▼	▼	▼	▼	▼
Front assist: Forward collision warning braking reaction to vehicles, pedestrians and cyclists	▼	▼	▼	▼	▼	▼	▼
Five headrests	▼	▼	▼	▼	▼	▼	▼
Folding boot cover (Sliding on Estate)	▼	▼	▼	▼	▼	▼	▼
Central locking system Keyless-Go	▼	-	-	-	-	-	-

▼ STANDARD | ▽ OPTIONAL | - NOT AVAILABLE



# SAFETY AND SECURITY

	V1	V2	V3	VZ1	VZ2	VZ3	VZ FIRST EDITION
KESY Advanced: Keyless start and keyless entry with SAFELOCK	-	▼	▼	▼	▼	▼	▼
ISOFIX points in outer rear seats with top tether anchorage points	▼	▼	▼	▼	▼	▼	▼
Lane Assist	▼	▼	-	▼	-	-	-
Dynamic Road Sign Display	▼	▼	▼	▼	▼	▼	▼
Side Assist (Blind spot monitor) with exit assist (audible and visual warnings of approaching traffic when opening doors)	-	-	▼	-	▼	▼	▼
Lane Change Assist with emergency Assist (Semi-autonomous vehicle control in an emergency)	-	-	▼	-	▼	▼	▼
Pre-crash front and rear seat belt tensioner, window closure and hazard lights	-	-	▼	-	▼	▼	▼
Seat belt reminder for front and rear seats	▼	▼	▼	▼	▼	▼	▼
Tiredness recognition system	▼	▼	▼	▼	▼	▼	▼
Tyre Pressure Monitoring System	▼	▼	▼	▼	▼	▼	▼

▼ STANDARD | ▽ OPTIONAL | - NOT AVAILABLE



# EXHAUST CONFIGURATIONS

	V1	V2	V3	VZ1	VZ2	VZ3	VZ FIRST EDITION
Rear diffuser with black simulated exhaust pipes	▼	▼	▼	-	-	-	-
Rear diffuser with copper simulated exhaust pipes (e-Hybrid only)	▼	▼	▼	▼	▼	▼	▼
Rear diffuser with twin oval exhaust pipe on each side (2.0 TSI only)	-	-	-	▼	▼	▼	-

# WARRANTY

	V1	V2	V3	VZ1	VZ2	VZ3	VZ FIRST EDITION
5 Year / 90,000mile Warranty	▼	▼	▼	▼	▼	▼	▼

▼ STANDARD | ▽ OPTIONAL | - NOT AVAILABLE



## WHEELS

	V1	V2	V3	VZ1	VZ2	VZ3	VZ FIRST EDITION	BASE PRICE (EXCL. VAT)	VAT @20%	BASE PRICE (INCL. VAT)
19" 'MISTRAL' alloy wheels in Machined Silver	-	-	▽	-	-	-	-	£0.00	£0.00	£0.00
Space saver spare wheel (in lieu of standard tyre repair kit) (not compatible with e-HYBRID)	▽	▽	▽	-	-	-	-	£108.33	£21.67	£130.00

## INTERIOR EQUIPMENT

	V1	V2	V3	VZ1	VZ2	VZ3	VZ FIRST EDITION	BASE PRICE (EXCL. VAT)	VAT @20%	BASE PRICE (INCL. VAT)
IMMERSIVE BY Sennheiser TM (Amplif. 10 speakers + 1 central speaker + 1 subwoofer) <sup>1</sup>	-	▽	▽	▽	▽	▼	▼	£441.67	£88.33	£530.00

1. Requires 'Space save spare wheel' (except for e-Hybrids and VZ3).



## FUNCTIONAL AND MECHANICAL

	V1	V2	V3	VZ1	VZ2	VZ3	VZ FIRST EDITION	BASE PRICE (EXCL. VAT)	VAT @20%	BASE PRICE (INCL. VAT)
Panoramic sunroof [5DR] <sup>2</sup>	-	▽	▽	▽	▽	▽	▼	£741.67	£148.33	£890.00
Panoramic sunroof [Estate] <sup>2</sup>	-	▽	▽	▽	▽	▽	▼	£820.83	£164.17	£985.00
Towbar pre-installation <sup>3</sup>	▽	▽	▽	▽	▽	▽	-	£129.17	£25.83	£155.00
Towbar pre-installation with hook <sup>3</sup>	▽	▽	▽	▽	▽	▽	-	£658.33	£131.67	£790.00

2. On e-HYBRID: not available with Tow bar pre-installation or Electric towing hook.  
3. On Hatch: not available on e-Hybrid engines.





## PAINT

	V1	V2	V3	VZ1	VZ2	VZ3	VZ FIRST EDITION	BASE PRICE (EXCL. VAT)	VAT @20%	BASE PRICE (INCL. VAT)
Non-metallic Fiord Blue	▽	▽	▽	▽	▽	▽	-	£0.00	£0.00	£0.00
Metallic Magnetic Tech Grey	▽	▽	▽	▽	▽	▽	-	£566.67	£113.33	£680.00
Metallic Midnight Black	▽	▽	▽	▽	▽	▽	-	£566.67	£113.33	£680.00
Metallic Glacial White	▽	▽	▽	▽	▽	▽	-	£566.67	£113.33	£680.00
Premium metallic Graphene Grey*	▽	▽	▽	▽	▽	▽	▽	£820.83	£164.17	£985.00
Premium metallic Taiga Grey	▽	▽	▽	▽	▽	▽	-	£820.83	£164.17	£985.00
Magnetic Tech Grey Matte	▽	▽	▽	▽	▽	▽	-	£1,695.83	£339.17	£2,035.00
Century Bronze Matte	-	-	-	▽	▽	▽	-	£1,695.83	£339.17	£2,035.00
Enceladus Grey Matte**	-	-	-	▽	▽	▽	▽	£1,695.83	£339.17	£2,035.00

\*Free option on VZ First Edition.

\*\*£1,355.00 (RRP) option for VZ First Edition.

▼ STANDARD | ▽ OPTIONAL | - NOT AVAILABLE



# UPHOLSTERY

	V1	V2	V3	VZ1	VZ2	VZ3	VZ FIRST EDITION	BASE PRICE (EXCL. VAT)	VAT @20%	BASE PRICE (INCL. VAT)
Black part-PVC part-cloth Sports seats with copper stitching	▼	-	-	-	-	-	-	£0.00	£0.00	£0.00
Soul Black Dinamica Bucket seats with copper stitching and embroidered CUPRA logo in headrest	-	▼	-	▼	-	-	▼	£0.00	£0.00	£0.00
Moon Slate Metallic leather Bucket seats with copper stitching and embroidered CUPRA logo in headrest	-	-	▼	-	▼	-	-	£0.00	£0.00	£0.00
Textile TURBINE CUP Bucket seats with sides in PVC Enceladus Grey and embroidered CUPRA logo in headrest	-	-	-	-	-	▼	-	£0.00	£0.00	£0.00



# ENGINE

<b>CUPRA Leon 5DR</b>	<b>1.5 TSI 150PS</b>	<b>1.5 eTSI DSG-Auto 150PS</b>	<b>2.0 TSI DSG-Auto 300PS</b>	<b>1.5 e-HYBRID DSG-Auto 204PS</b>	<b>1.5 e-HYBRID DSG-Auto 272PS</b>
Type (cylinders / valves per cylinder)	4/4	4/4	4/4	4/4	4/4
Displacement (cc)	1498	1498	1984	1498	1498
Bore and stroke (mm)	74.5 / 85.9	74.5 / 85.9	82.5 / 92.8	74.5 / 85.9	74.5 / 85.9
Compression ratio	12	12	9.3	11.5	11.5
Maximum power ( kW (PS) / rpm) <sup>1</sup>	110 (150) / 5000-6000	110 (150) / 5000-6000	221 (300) / 5300-6500	110 [ 150] / 5000-6000*	130 (177) / 5500-6000*
Maximum torque (Nm / rpm)	250 / 1500- 3500	250 / 1500-3500	400 / 2000-5200	250 / 1500-4000	250 / 1500-4000
Fuel supply system	TSI Direct Injection	TSI Direct Injection	TSI Direct Injection	TSI Direct Injection	TSI Direct Injection
Fuel type	Unleaded petrol	Unleaded petrol	Unleaded petrol	Unleaded petrol / Electric	Unleaded petrol / Electric
Emission control	RDE 2	RDE 2	RDE 2	RDE 2	RDE 2
Start/stop system	Yes	Yes	Yes	Yes	Yes

1. The maximum power output figures are quoted in PS (or Pferdestärke, which is the metric equivalent of horsepower). To convert from metric to imperial horsepower, divide the PS by 1.0139.

\*Combustion engine figures only. Full system (battery and petrol engine) Max power: 150kW, 204PS and 200 kW, 272PS; Max torque 350Nm and 400Nm



# TRANSMISSION AND PERFORMANCE

<b>CUPRA Leon 5DR</b>	<b>1.5 TSI 150PS</b>	<b>1.5 eTSI DSG-Auto 150PS</b>	<b>2.0 TSI DSG-Auto 300PS</b>	<b>1.5 e-HYBRID DSG-Auto 204PS</b>	<b>1.5 e-HYBRID DSG-Auto 272PS</b>
Gearbox type	6-speed manual	7-speed automatic	7-speed automatic	6-speed automatic	6-speed automatic
Maximum speed (km/h)	215	215	250	220	229
Maximum speed (mph) <sup>2</sup>	134	134	155	137	142
Acceleration 0-62mph (s) (0-100 KM/H (S))	8.9	8.7	5.7	7.7	7.1
WLTP – Combined WLTP range (MPG)	44.8-48.7	47.9-51.4	36.2-37.2	706.2-706.2	706.2-706.2

<sup>2</sup> Where law permits.



# ELECTRIC ENGINE AND CHARGING

<b>CUPRA Leon 5DR</b>	<b>1.5 TSI 150PS</b>	<b>1.5 eTSI DSG-Auto 150PS</b>	<b>2.0 TSI DSG-Auto 300PS</b>	<b>1.5 e-HYBRID DSG-Auto 204PS</b>	<b>1.5 e-HYBRID DSG-Auto 272PS</b>
Max Power (kw / PS) <sup>1</sup>	-	-	-	85 (116)*	85 (116)*
Max Torque (nm)	-	-	-	330*	330*
Battery type	-	-	-	Li-ion	Li-ion
Battery capacity (ah)	-	-	-	408	63.2
Battery capacity (kw/h)	-	-	-	63.2	25.8
Battery voltage (v)	-	-	-	25.8	408
Battery cells	-	-	-	96 (8 modules, 12 cells each)	96 (8 modules, 12 cells each)
Charge type (AC / DC)	-	-	-	AC / DC	AC / DC
Charging time AC 11kw 0-100%	-	-	-	2hrs 30mins	2hrs 30mins
Charging time DC 50kw 10-80%	-	-	-	26mins	26mins

1. The maximum power output figures are quoted in PS (or Pferdestärke, which is the metric equivalent of horsepower). To convert from metric to imperial horsepower, divide the PS by 1.0139.

\*Full system (battery and petrol engine) Max power: 150kW, 204PS and 200 kW, 272PS; Max torque 350Nm and 400Nm.



# ELECTRIC CONSUMPTION

<b>CUPRA Leon 5DR</b>	<b>1.5 TSI 150PS</b>	<b>1.5 eTSI DSG-Auto 150PS</b>	<b>2.0 TSI DSG-Auto 300PS</b>	<b>1.5 e-HYBRID DSG-Auto 204PS</b>	<b>1.5 e-HYBRID DSG-Auto 272PS</b>
Electric consumption combined WLTP (kwh / 100km)	-	-	-	16.8-17.8	16.5-16.9
Electric range WLTP (km)	-	-	-	125-133	121-125
Electric range WLTP (miles)	-	-	-	77.6-82.6	75-77



## TRIM & EMISSION (WLTP) CO<sub>2</sub> (G/KM)

<b>CUPRA Leon 5DR</b>	<b>1.5 TSI 150PS</b>	<b>1.5 eTSI DSG-Auto 150PS</b>	<b>2.0 TSI DSG-Auto 300PS</b>	<b>1.5 e-HYBRID DSG-Auto 204PS</b>	<b>1.5 e-HYBRID DSG-Auto 272PS</b>
V1	132	124	-	9	-
V2	137	129	-	9	-
V3	137	129	-	8	-
VZ1	-	-	174	-	9
VZ2	-	-	173	-	9
VZ3	-	-	175	-	10
VZ First Edition	-	-	-	-	10



# CHASSIS AND BRAKING SYSTEM

<b>CUPRA Leon 5DR</b>	<b>1.5 TSI 150PS</b>	<b>1.5 eTSI DSG-Auto 150PS</b>	<b>2.0 TSI DSG-Auto 300PS</b>	<b>1.5 e-HYBRID DSG-Auto 204PS</b>	<b>1.5 e-HYBRID DSG-Auto 272PS</b>
Front suspension	Independent type McPherson – coil springs – hydraulic shock absorber [DCC equipment (Adaptive chassis control) on V2 and V3]		Independent type McPherson – coil springs – hydraulic shock absorber		
Rear suspension	Semirigid axle (with 18" Rims) / Multilink axle (with 19" Rims), coil springs and hydraulic shock absorber [DCC equipment (Adaptive chassis control) on V2 and V3]		Multilink axle (>110kW and PHEV), coil springs and hydraulic shock absorber		
Steering system	R-EPS Progressive steering	R-EPS Progressive steering	R-EPS Progressive steering	R-EPS Progressive steering	R-EPS Progressive steering
Turning circle diameter (m)	10,8	10,8	10,8	10,8	10,8
Anti-lock Braking System (ABS)	Dual hydraulic circuit and brake system diagonal split with electric brake booster				
Type (front / rear)	Front ventilated disc brakes and rear solid disc brakes				
Front discs (mm)	288 x 25 (306 x 26 with Dynamic Chassis Control)	288 x 25 (306 x 26 with Dynamic Chassis Control)	357 x 34 (375 x 36 with Performance Brakes)	340 x 30	340 x 30 (370 x 32 with Performance Brakes)
Rear discs (mm)	272 x 10	272 x 10	310 x 22	310 x 22	310 x 22





# WEIGHTS

<b>CUPRA Leon 5DR</b>	<b>1.5 TSI 150PS</b>	<b>1.5 eTSI DSG-Auto 150PS</b>	<b>2.0 TSI DSG-Auto 300PS</b>	<b>1.5 e-HYBRID DSG-Auto 204PS</b>	<b>1.5 e-HYBRID DSG-Auto 272PS</b>
Kerb weight [with driver] (kg)	1373 (V1 trim) / 1409 (V2, V3 trim)	1401 (V1 trim) / 1441 (V2, V3 trim)	1496	1673	1708
Permissible gross weight (kg)	1860 (V1 trim) / 1880 (V2, V3 trim)	1890 (V1 trim) / 1910 (V2, V3 trim)	2000	2130	2140
Max. towing weight without brake (kg)	680 (V1 trim) / 700 (V2, V3 trim)	700 (V1 trim) / 720 (V2, V3 trim)	740	-	-
Max. towing weight with brake 8% (kg)	1700	1700	1800	-	-
Max. towing weight with brake 12% (kg)	1500	1500	1600	-	-



# DIMENSIONS

<b>CUPRA Leon 5DR</b>	<b>1.5 TSI 150PS</b>	<b>1.5 eTSI DSG-Auto 150PS</b>	<b>2.0 TSI DSG-Auto 300PS</b>	<b>1.5 e-HYBRID DSG-Auto 204PS</b>	<b>1.5 e-HYBRID DSG-Auto 272PS</b>
Max Length / width / height (mm)	4398 / 1799 / 1444	4398 / 1799 / 1444	4398 / 1799 / 1444	4399 / 1799 / 1467	4399 / 1799 / 1467
Boot capacity (l)	380	380	380	270	270
Fuel tank capacity (l)	45 (V1 trim) / 50 (V2, V3 trim)	45 (V1 trim) / 50 (V2, V3 trim)	50	40	40

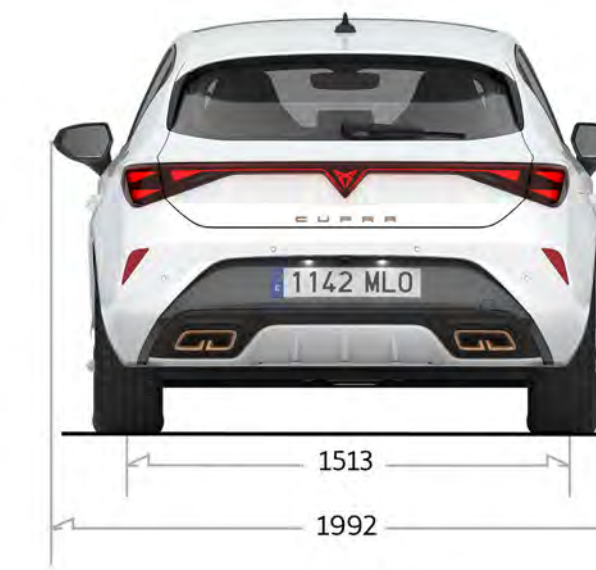
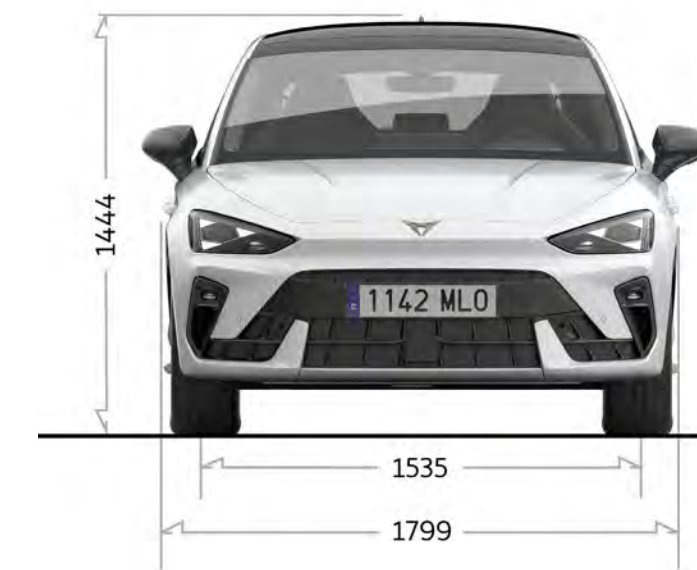
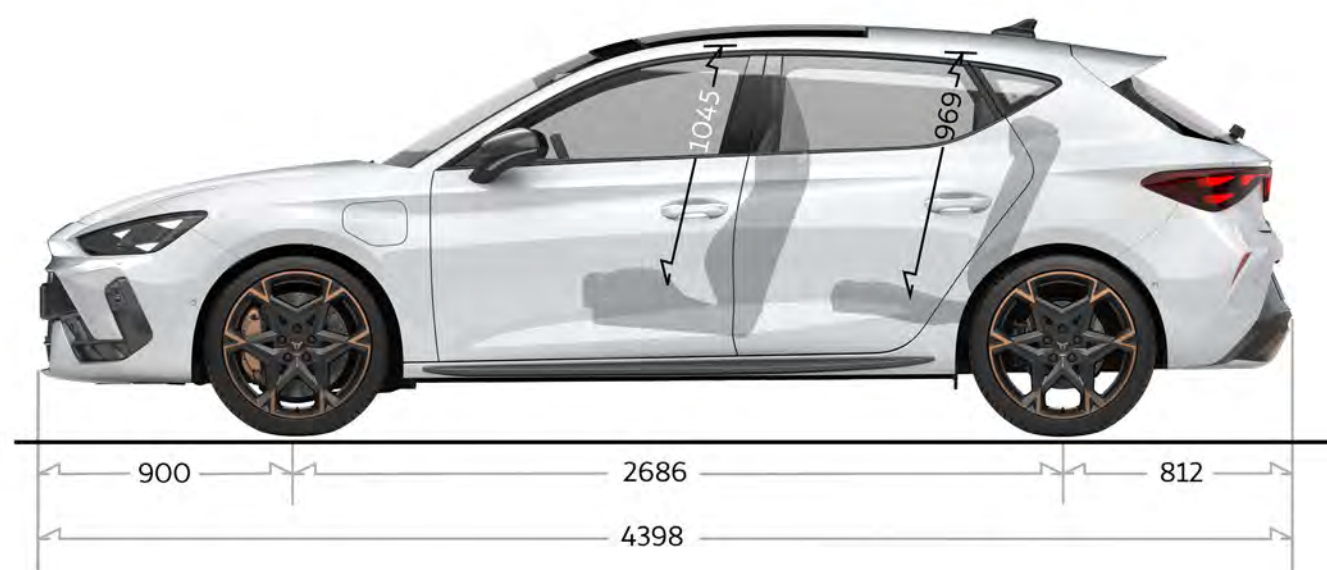



# ENGINE

<b>CUPRA Leon Estate</b>	<b>1.5 TSI 150PS</b>	<b>1.5 eTSI DSG-Auto 150PS</b>	<b>2.0 TSI DSG-Auto 4Drive 333PS</b>	<b>1.5 e-HYBRID DSG-Auto 204PS</b>	<b>1.5 e-HYBRID DSG-Auto 272PS</b>
Type (cylinders / valves per cylinder)	4/4	4/4	4/4	4/4	4/4
Displacement (cc)	1498	1498	1984	1498	1498
Bore and stroke (mm)	74.5 / 85.9	74.5 / 85.9	82.5 / 92.8	74.5 / 85.9	74.5 / 85.9
Compression ratio	12	12	9.3	11.5	11.5
Maximum power ( kW (PS) / rpm) <sup>1</sup>	110 (150) / 5000-6000	110 (150) / 5000-6000	245 (333) / 5600-6500	110 (150)* / 5000-6000	130 (177)* / 5500-6000
Maximum torque (Nm / rpm)	250 / 1500-3500	250 / 1500-3500	420 / 2100-5500	250* / 1500-4000	250* / 1500-4000
Fuel supply system	TSI Direct Injection	TSI Direct Injection	TSI Direct Injection	TSI Direct Injection	TSI Direct Injection
Fuel type	Unleaded petrol	Unleaded petrol	Unleaded petrol	Unleaded petrol / Electric	Unleaded petrol / Electric
Emission control	RDE 2	RDE 2	RDE 2	RDE 2	RDE 2
Start/stop system	Yes	Yes	Yes	Yes	Yes

<sup>1</sup> The maximum power output figures are quoted in PS (or Pferdestärke, which is the metric equivalent of horsepower). To convert from metric to imperial horsepower, divide the PS by 1.0139.

\*Combustion engine figures only. Full system (battery and petrol engine) Max power: 150kW, 204PS and 200 kW, 272PS; Max torque 350Nm and 400Nm.



# TRANSMISSION AND PERFORMANCE

<b>CUPRA Leon Estate</b>	<b>1.5 TSI 150PS</b>	<b>1.5 eTSI DSG-Auto 150PS</b>	<b>2.0 TSI DSG-Auto 4Drive 333PS</b>	<b>1.5 e-HYBRID DSG-Auto 204PS</b>	<b>1.5 e-HYBRID DSG-Auto 272PS</b>
Gearbox type	6-speed manual	7-speed automatic	7-speed automatic	6-speed automatic	6-speed automatic
Maximum speed (km/h)	216	216	250	220	229
Maximum speed (mph) <sup>2</sup>	134	134	155	137	142
Acceleration 0-62mph (s) (0-100 KM/H (S))	9.2	9.0	4.8	7.7	7.3
WLTP – Combined WLTP range (MPG)	44.1-47.9	47.1-51.4	47.1-51.4	706.2-706.2	565.0-706.2

<sup>2</sup> Where law permits.



# ELECTRIC ENGINE AND CHARGING

<b>CUPRA Leon Estate</b>	<b>1.5 TSI 150PS</b>	<b>1.5 eTSI DSG-Auto 150PS</b>	<b>2.0 TSI DSG-Auto 4Drive 333PS</b>	<b>1.5 e-HYBRID DSG-Auto 204PS</b>	<b>1.5 e-HYBRID DSG-Auto 272PS</b>
Max Power (kw / PS) <sup>1</sup>	-	-	-	85 (116)*	85 (116)*
Max Torque (nm)	-	-	-	330*	330*
Battery type	-	-	-	Li-ion	Li-ion
Battery capacity (ah)	-	-	-	408	408
Battery capacity (kw / h)	-	-	-	63.2	63.2
Battery voltage (v)	-	-	-	25.8	25.8
Battery cells	-	-	-	96 (8 modules, 12 cells each)	96 (8 modules, 12 cells each)
Charge type (AC / DC)	-	-	-	AC / DC	AC / DC
Charging time AC 11kw 0-100%	-	-	-	2hrs 30mins	2hrs 30mins
Charging time DC 50kw 10-80%	-	-	-	26mins	26mins

1. The maximum power output figures are quoted in PS (or Pferdestärke, which is the metric equivalent of horsepower). To convert from metric to imperial horsepower, divide the PS by 1.0139.

\*Full system (battery and petrol engine) Max power: 150kW, 204PS and 200 kW, 272PS; Max torque 350Nm and 400Nm.



# ELECTRIC CONSUMPTION

<b>CUPRA Leon Estate</b>	<b>1.5 TSI 150PS</b>	<b>1.5 eTSI DSG-Auto 150PS</b>	<b>2.0 TSI DSG-Auto 4Drive 333PS</b>	<b>1.5 e-HYBRID DSG-Auto 204PS</b>	<b>1.5 e-HYBRID DSG-Auto 272PS</b>
Electric consumption combined WLTP (kwh / 100km)	-	-	-	17-18	16.6-17.1
Electric range WLTP (km)	-	-	-	124-131	120-124
Electric range WLTP (miles)	-	-	-	77-81	74-77



## TRIM & EMISSION (WLTP) CO<sub>2</sub> (G/KM)

<b>CUPRA Leon Estate</b>	<b>1.5 TSI 150PS</b>	<b>1.5 eTSI DSG-Auto 150PS</b>	<b>2.0 TSI DSG-Auto 300PS</b>	<b>1.5 e-HYBRID DSG-Auto 204PS</b>	<b>1.5 e-HYBRID DSG-Auto 272PS</b>
V1	134	126	-	9	-
V2	139	130	-	9	-
V3	139	130	-	9	-
VZ1	-	-	188	-	10
VZ2	-	-	188	-	10
VZ3	-	-	189	-	10
VZ First Edition	-	-	-	-	11



# CHASSIS AND BRAKING SYSTEM

<b>CUPRA Leon Estate</b>	<b>1.5 TSI 150PS</b>	<b>1.5 eTSI DSG-Auto 150PS</b>	<b>2.0 TSI DSG-Auto 4Drive 333PS</b>	<b>1.5 e-HYBRID DSG-Auto 204PS</b>	<b>1.5 e-HYBRID DSG-Auto 272PS</b>
Front suspension	Independent type McPherson – coil springs – hydraulic shock absorber [DCC equipment (Adaptive chassis control) on V2 and V3]		Independent type McPherson – coil springs – hydraulic shock absorber		
Rear suspension	Semirigid axle (with 18" Rims) / Multilink axle (with 19" Rims), coil springs and hydraulic shock absorber [DCC equipment (Adaptive chassis control) on V2 and V3]		Multilink axle (>110kW and PHEV), coil springs and hydraulic shock absorber		
Steering system	R-EPS (Rack Electric Power System); Progressive steering	R-EPS (Rack Electric Power System); Progressive steering	R-EPS (Rack Electric Power System); Progressive steering	R-EPS (Rack Electric Power System); Progressive steering	R-EPS (Rack Electric Power System); Progressive steering
Turning circle diameter (m)	10,8	10,8	10,8	10,8	10,8
Anti-lock Braking System (ABS)	Dual hydraulic circuit and brake system diagonal split with electric brake booster				
Type (front / rear)	Front ventilated disc brakes and rear solid disc brakes				
Front discs (mm)	288 x 25 (306 x 26 with Dynamic Chassis Control)		357 x 34 (375 x 36 with Performance Brakes)	340 x 30	340 x 30 (370 x 32 with Performance Brakes)
Rear discs (mm)	272 x 10	272 x 10	310 x 22	310 x 22	310 x 22





# WEIGHTS

<b>CUPRA Leon Estate</b>	<b>1.5 TSI 150PS</b>	<b>1.5 eTSI DSG-Auto 150PS</b>	<b>2.0 TSI DSG-Auto 4Drive 333PS</b>	<b>1.5 e-HYBRID DSG-Auto 204PS</b>	<b>1.5 e-HYBRID DSG-Auto 272PS</b>
Kerb weight [with driver] (kg)	1419 (V1 trim) / 1454 (V2, V3 trim)	1447 (V1 trim) / 1486 (V2, V3 trim)	1651	1720	1756
Permissible gross weight (kg)	1940 (V1 trim) / 1970 (V2, V3 trim)	1970 (V1 trim) / 2000 (V2, V3 trim)	2150	2140	2150
Max. towing weight without brake (kg)	700 (V1 trim) / 720 (V2, V3 trim)	720 (V1 trim) / 740 (V2, V3 trim)	750	750	750
Max. towing weight with brake 8% (kg)	1700	1700	1900	1700	1700
Max. towing weight with brake 12% (kg)	1500	1500	1700	1700	1700



# DIMENSIONS

<b>CUPRA Leon Estate</b>	<b>1.5 TSI 150PS</b>	<b>1.5 eTSI DSG-Auto 150PS</b>	<b>2.0 TSI DSG-Auto 4Drive 333PS</b>	<b>1.5 e-HYBRID DSG-Auto 204PS</b>	<b>1.5 e-HYBRID DSG-Auto 272PS</b>
Max Length / width / height (mm)	4656 / 1799 / 1438	4657 / 1799 / 1438	4659 / 1799 / 1438	4657 / 1799 / 1463	4657 / 1799 / 1463
Boot capacity (l)	620	620	620	470	470
Fuel tank capacity (l)	45 (V1 trim) / 50 (V2, V3 trim)	45 (V1 trim) / 50 (V2, V3 trim)	55	40	40

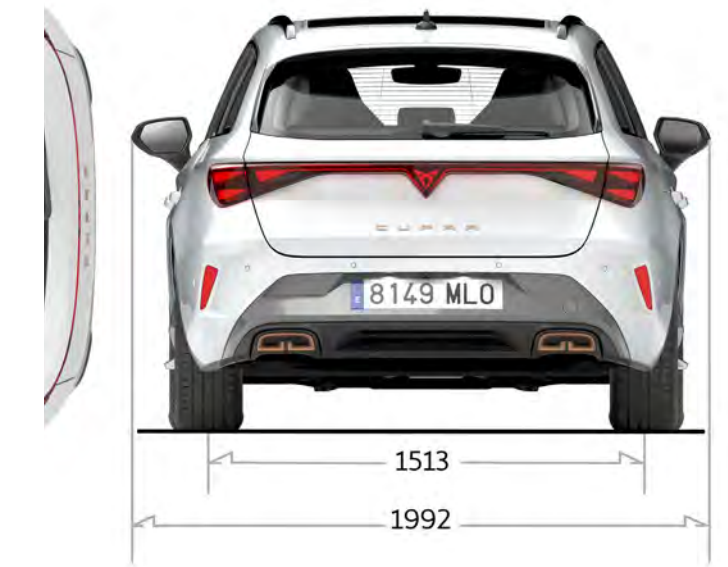
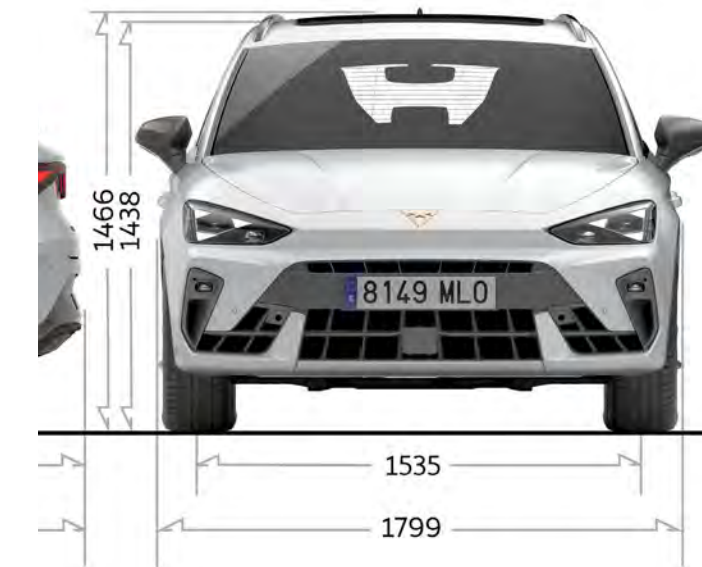
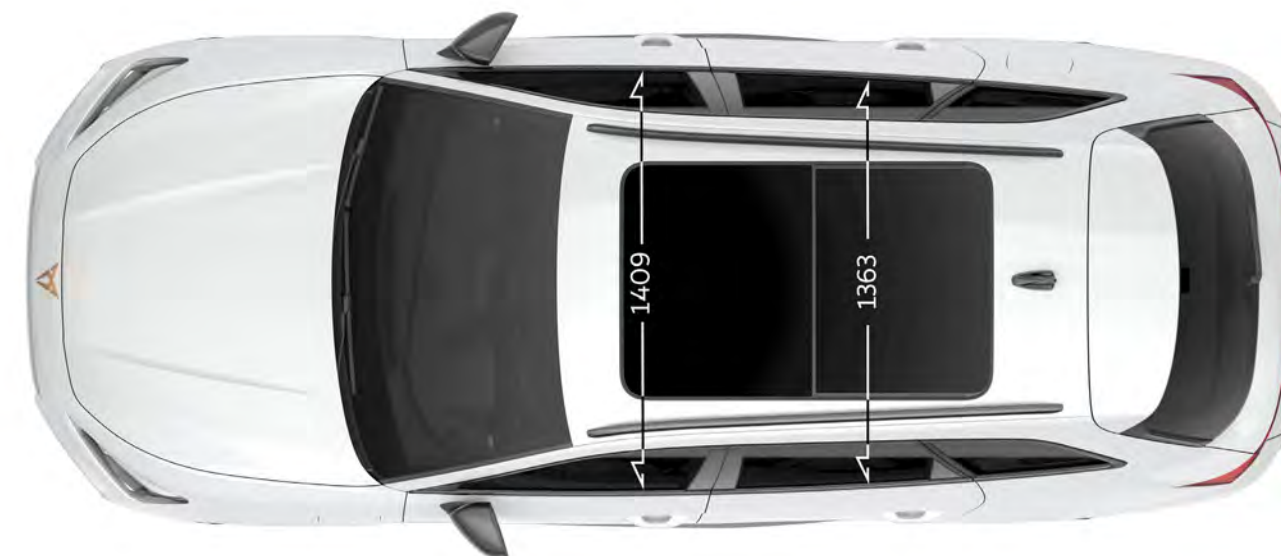
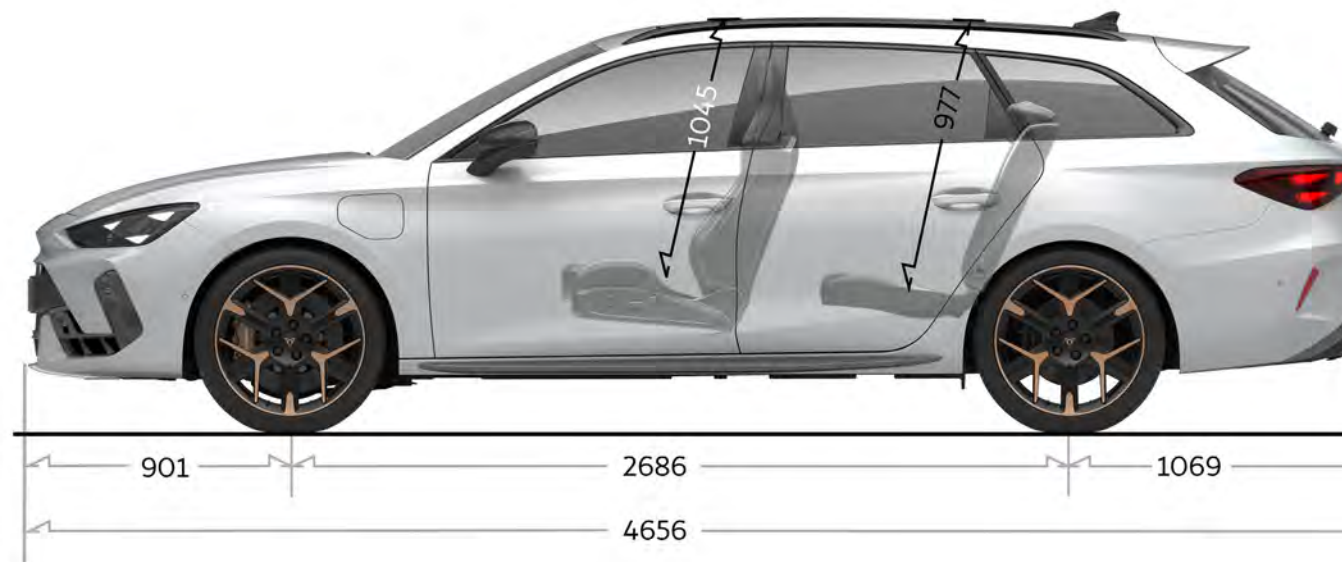



# YOUR TYRE LABEL

They may not be the first part of your CUPRA you notice, but your tyres play a vital role in keeping you on the road. Your EU tyre label tells you everything you need to know. Due to the variation of tyres that may be fitted during production, the configurator will show multiple tyre labels. It is not possible to select a specific tyre when ordering a vehicle.

You'll see more in-depth information on your tyres while configuring your car. Click [here](#) to start building your CUPRA now.

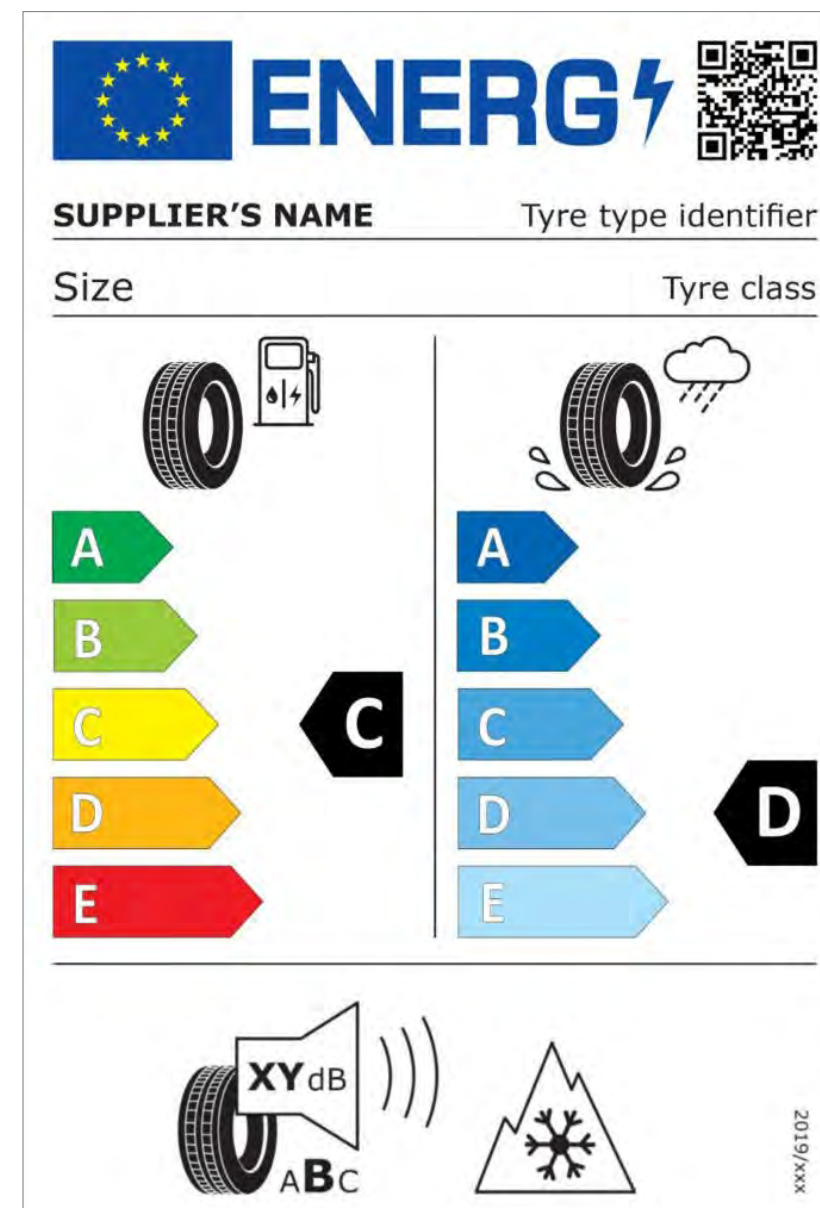
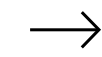

## ENERGY EFFICIENCY

This is a measure of 'rolling resistance' – in other words, the amount of energy lost through motion. The lower the rolling resistance, the lower your energy consumption, with tyres rated as class A being the most efficient.

## WET GRIP

Rigorous testing ensures your tyres give great handling and performance in all conditions. Wet grip specifically measures how well you can brake in wet conditions, with grade A giving the shortest stopping distance.

## EXTERNAL NOISE

Tyres are carefully measured so you know exactly how much noise they'll make while driving. If decibels don't mean a lot to you, don't worry. Each tyre also falls into a noise class-A being the quietest and C the loudest.



# VEHICLE EXCISE DUTY

All new vehicles are subject to a form of Vehicle Excise Duty (VED) based on the type of fuel the vehicle uses and its carbon dioxide (CO<sub>2</sub>) emission level, measured in grams per kilometre (g/km). The table below illustrates the duty you will pay based on the DVLA bandings.

The standard rate for Petrol and Diesel is £190 and £180 for Alternative Fuel Vehicles. Please be aware vehicles with a list price (RRP), including options, higher than £40,000 will incur an additional £410 a year in vehicle tax.

For full details please refer to [gov.uk/vehicle-tax-rate-tables](https://gov.uk/vehicle-tax-rate-tables)



## 12-MONTH ROAD FUND LICENCE (RFL) RATE FOR PETROL, DIESEL AND ALTERNATIVE FUEL VEHICLES

CO <sub>2</sub> g/km	1ST YEAR RATE PETROL / DIESEL	1ST YEAR RATE ALTERNATIVE FUEL VEHICLES (AFVs)
0	£0	£0
1	£10	£0
51	£30	£20
76	£135	£125
91	£175	£165
101	£195	£185
111	£220	£210
131	£270	£260
151	£680	£670
171	£1,095	£1,085
191	£1,650	£1,640
226	£2,340	£2,330
256	£2,745	£2,735

CARS REGISTERED ON OR AFTER 1 APRIL 2024

[FIND A RETAILER](#)[TEST DRIVE](#)[CONFIGURE](#)[← CONTENTS →](#)

# BENEFIT IN KIND TAX

## HOW TO CALCULATE YOUR LIABILITY

The BIK percentage value is based on the CO<sub>2</sub> emissions of the vehicle for the current tax year 2024 / 25.



### BIK CALCULATION EXAMPLE: CUPRA LEON VZ1 E-HYBRID DSG-AUTO 272

P11D value (Manufacturer's Direct Price price less RFL and first registration fee)	£42,020.00
WLTP CO <sub>2</sub> emissions (g/km)	10
Company car BIK tax based on CO <sub>2</sub> emission level	5%
Taxable BIK (for 2024 / 25 tax year): 5% of £42,020.00	£2,101.00

### ANNUAL COMPANY CAR TAX 2024 / 25 (@20% INCOME TAX)

20% of £2,101.00	£420.20 per annum
------------------	-------------------

### MONTHLY COMPANY CAR TAX 2024/25 (@20% INCOME TAX)

£420.20 divided by 12	£35.02 per month
-----------------------	------------------



# WARRANTIES

## **FIVE-YEAR MANUFACTURER WARRANTY**

All new CUPRA's ordered on or after 03/04/2024 in the UK, come with a five year/90,000 miles warranty, which protects your car against the failure of most mechanical and electrical components due to manufacturing defects. This comprises a two-year manufacturer's warranty with unlimited mileage, plus a further 3 years up to a maximum of 90,000 miles (whichever is soonest).

## **THREE-YEAR PAINT WARRANTY**

The paintwork of all models featured in this price list is covered against manufacturing defects for a period of three years. Naturally, the vehicle must be cared for in compliance with the operating instructions which will be found in your vehicle handbook. Please consult your authorised CUPRA Retailer or repairer for full warranty details.

## **TWELVE-YEAR BODY PROTECTION WARRANTY**

The internal body sections and panels of the models featured in this price list are covered against corrosion originating from internal cavities for twelve years. Naturally, the vehicle must be cared for in compliance with the operating instructions which will be found in your vehicle handbook. Please consult your authorised CUPRA Retailer or repairer for full warranty details.



## **CUPRA PARTS WARRANTY**

CUPRA parts and accessories supplied after new vehicle delivery are covered by our 24 months parts warranty.

## **CUPRA ROADSIDE ASSISTANCE (INCLUDING EUROPEAN COVER)**

Any new CUPRA purchased and registered in the UK from an authorised CUPRA Retailer, is covered free by CUPRA Assistance (including European cover) for roadside repairs or recovery to an authorised repairer for a term of two years. Terms and conditions apply.

## **SPECIFICATIONS**

Specifications refer to Model Year 2024. While CUPRA makes every effort to make sure that specifications are accurate at time of going to press (04 / 2024), you should always check details with your CUPRA Retailer as there may have been changes in view of CUPRA's policy of continuous product improvement. The right is reserved to change specification and colour at any time. The information in this price list can therefore be given as guidance only.



# CUPRA CARE PLAN

DESIGNED TO LOOK AFTER YOUR CUPRA AND YOU

**DRIVE THE DIFFERENCE**  
**SERVICING AND MAINTENANCE FOR CUPRAS UP TO 12 MONTHS OLD**

Take caring for your CUPRA to the next level with a plan designed to suit a car as unique as yours.

With three levels of care, you can choose the package that suits your individual needs. A CUPRA Care Plan\* makes sure your car is always operating at peak performance because we only use CUPRA Genuine Parts, fitted by our trained CUPRA Specialists.

The great thing about a CUPRA Care Plan is no matter what level of care you choose, you'll receive:

- Complimentary delivery and collection\*\*
- CUPRA courtesy clean
- A video of your CUPRA service
- A minimum of 10% off merchandise

And by spreading the cost into manageable monthly payments, starting from just £4.13 a month (on plans activated within 90 days of new car registration), you can make caring for your CUPRA that bit easier.

\*Available for CUPRA vehicles up to 12 months old only. Price valid until 01/01/2025. Battery electric vehicles excluded. T&Cs apply. Servicing must be carried out in line with the requirement of the service schedule. Offer excludes vehicles with performance brakes with front Brembo or Akenbono calipers. All work must be carried out at an authorised CUPRA Retailer. Excludes additional remedial work outside of the plan inclusions. Offer may be varied or withdrawn at any time. Plan validity is dependent on required payments received. Administered by SEAT Financial Services.

\*\*Collection & delivery subject to Retailer availability. Drop off and collection, loan car or courtesy lift may also be offered as an alternative to help keep you moving.





# LEVELS OF COVER

CHOOSE THE PACKAGE RIGHT FOR YOU. SPREAD THE COST OR PAY UPFRONT<sup>^</sup>.



## LEVEL 1

### Your first two services:

- + 1 pollen filter replacement
- + 10% off all merchandise

£4.13 a month over 24 monthly payments, for cars aged 0 to 90 days.

£19.75 a month over 24 monthly payments, for cars aged 90 days to 12 months.

## LEVEL 2

### Your first two services:

- + 1 pollen filter replacement
- + 1 set of front wiper blades
- + 1 set of front brake pads
- + 15% off all merchandise

£16.63 a month over 24 monthly payments, for cars aged 0 to 90 days.

## LEVEL 3

### Your first three services:

- + 1 pollen filter replacement
- + 1 set of front wiper blades
- + 1 set of front brake pads
- + 1 set of spark plugs (if required)
- + 1 brake fluid change
- + Your first MOT
- + 20% off all merchandise

£22.19 a month over 36 monthly payments, for cars aged 0 to 90 days.

Enjoy the peace of mind that your CUPRA is being taken care of with a package that suits you.

Buy a CUPRA Care Plan today. Contact your nearest Retailer to purchase.

CUPRA FINANCE OFFERS

<sup>^</sup>Upfront offer pricing for level 1 is £99, level 2 is £399, level 3 is £799 and standard upfront pricing is £474 for level 1.





CUPRA is committed to a policy of continuous product development and reserves the right to make changes to specifications, colours and prices without notice. The information in this brochure can therefore be given as guidance only. While CUPRA makes every effort to ensure that specifications are accurate at the time of publication, you should always check with your authorised CUPRA Retailer for the latest information. Due to limitations of the printing process, the colours reproduced in this brochure may vary slightly from the actual paint colour and material. This vehicle and all its parts, as well as the original spares, were designed according to the Legal Regulations governing the prevention and minimisation of Environmental Impact, through the use of recycled / recyclable materials, with measures taken to achieve suitable recycling for the conservation and improvement of environmental quality.

Published in the UK, July 2024

12192108\_0702024

CUPRA